

TIFLUX:10



10HP CYCLONE
AUTO CLEAN TIMING SYSTEM

LAGUNA



TABLE OF CONTENTS

- Important Safety Instructions
- Safety Guidelines - Definitions
- General Safety Rules
 - Additional Safety For Dust Collectors
 - Power Connections
 - Motor Specifications
 - Grounding Instructions
- Key Features and Components
- Functional Description
- Product Specifications
- Unpacking
- Assembly
 - General Tool Assembly
- Maintenance Procedures
 - Cleaning the Filter
 - Changing the Filter Bag
 - Emptying the Drum
 - Routine Inspection
- Trouble Shooting
- Parts breakdown and parts list

IMPORTANT SAFETY INSTRUCTIONS

WARNING

READ AND UNDERSTAND ALL WARNINGS AND OPERATING INSTRUCTIONS BEFORE USING THIS EQUIPMENT. Failure to follow all instructions listed below, may result in electric shock, fire, and/or serious personal injury or property damage.

Woodworking can be dangerous if safe and proper operating procedures are not followed. As with all machinery, there are certain hazards involved with the operation of the product. Using the machine with respect and caution will considerably lessen the possibility of personal injury. However, if normal safety precautions are overlooked or ignored, personal injury to the operator may result. Safety equipment such as guards, push sticks, hold-downs, featherboards, goggles, dust masks and hearing protection can reduce your potential for injury. But even the best guard won't make up for poor judgment, carelessness or inattention. **Always use common sense** and exercise caution in the workshop. If a procedure feels dangerous, don't try it. Figure out an alternative procedure that feels safer. **REMEMBER:** Your personal safety is your responsibility.

WARNING

This machine was designed for certain applications only. We strongly recommend that this machine not be modified and/or used for any application other than that for which it was designed. If you have any questions relative to a particular application, DO NOT use the machine until you have first contacted the manufacturer to determine if it can or should be performed on the product.

If you have any questions relative to its application DO NOT use the product until you have contacted the manufacturer and we have advised you.

When using an electrical appliance, basic precautions should always be followed, including the following:

READ ALL INSTRUCTIONS BEFORE USING (THIS APPLIANCE)

WARNING

To reduce the risk of fire, electric shock, or injury:

1. Do not leave appliance when plugged in. Unplug from outlet when not in use and before servicing.
2. Do not use outdoors or on wet surfaces
3. Do not allow to be used as a toy. Close attention is necessary when used by or near children.
4. Use only as described in this manual. Use only manufacturer's recommended attachments.



5. Do not use with damaged cord or plug. If appliance is not working as it should, has been dropped, damaged, left outdoors, or dropped into water, return it to a service center.
6. Do not pull or carry by cord, use cord as a handle, close a door on cord, or pull cord around sharp edges or corners. Do not run appliance over cord. Keep cord away from heated surfaces.
7. Do not unplug by pulling on cord. To unplug, grasp the plug, not the cord.
8. Do not handle plug or appliance with wet hands.
9. Do not put any object into openings. Do not use with any opening blocked; keep free of dust, lint, hair, and anything that may reduce air flow.
10. Keep hair, loose clothing, fingers, and all parts of body away from openings and moving parts.
11. Turn off all controls before unplugging.
12. Use extra care when cleaning on stairs.
13. Do not use to pick up flammable or combustible liquids, such as gasoline, or use in areas where they may be present.
14. Connect to a properly grounded outlet only. See Grounding Instructions.

SAVE THESE INSTRUCTIONS

1. Read and understand the warnings posted on the machine and in this manual. Failure to comply with all of these warnings may cause serious injury.
2. Replace the warning labels if they become obscured or removed.
3. This 3HP Portable Cyclone Dust Collector is designed and intended for use by properly trained and experienced personnel only. If you are not familiar with the proper and safe operation of this type of dust collector, do not use until proper training and knowledge have been obtained.
4. Do not use this machine for other than its intended use. If used for other purposes, **LAGUNA TOOLS INC.**, disclaims any real or implied warranty and holds itself harmless from any injury that may result from that use.
5. Always wear approved safety glasses/face shields while using this machine.
6. Before operating this dust collector, remove tie, rings, watches and other jewelry, and roll sleeves up past the elbows. Remove all loose clothing and confine long hair. Non-slip footwear or anti-skid floor strips are recommended. Do **not** wear gloves.
7. Wear ear protectors (plugs or muffs) during extended periods of operation.
8. Some dust created by power sanding, sawing, grinding, drilling and other construction activities contain chemicals known to cause cancer, birth defects or other reproductive harm. Some examples of these chemicals are:
 - Lead from lead based paint.

LAGUNA

- Crystalline silica from bricks, cement and other masonry products.
- Arsenic and chromium from chemically treated lumber.

Your risk of exposure varies, depending on how often you do this type of work. To reduce your exposure to these chemicals, work in a well-ventilated area and work with approved safety equipment, such as face or dust masks that are specifically designed to filter out microscopic particles.

9. Do not operate this machine while tired or under the influence of drugs, alcohol or any medication.
10. Make certain the switch is in the **OFF** position before connecting the machine to the power source.
11. Make certain the machine is properly grounded.
12. Make all machine adjustments or maintenance with the machine unplugged from the power source.
13. Form a habit of checking to see that all extra equipment such as adjusting keys, wrenches, scrap, stock, and cleaning rags are removed away from the machine before turning on.
14. Keep safety guards in place at all times when the machine is in use. If removed for maintenance purposes, use extreme caution and replace the guards immediately when maintenance is complete.
15. Make sure the dust collector is on a flat even surface and the wheels locked in place before use.
16. Check damaged parts. Before further use of the machine, a guard or other part that is damaged should be carefully checked to determine that it will operate properly and perform its intended function. Check for alignment of moving parts, binding of moving parts, breakage of parts, mounting and any other conditions that may affect its operation. A guard or other part that is damaged should be properly repaired or replaced.
17. Provide for adequate space surrounding work area and non-glare, overhead lighting.
18. Keep the floor around the machine clean and free of scrap material, oil and grease.
19. Keep visitors a safe distance from the work area. **Keep children away.**
20. Make your workshop child proof with padlocks, master switches or by removing starter keys.

LAGUNA

22. Maintain a balanced stance at all times so that you do not fall or lean against the dust collector. Do not overreach or use excessive force to perform any machine operation.
23. Use the right tool at the correct speed and feed rate. Do not force a tool or attachment to do a job for which it was not designed. The right tool will do the job better and safer.
24. Use recommended accessories; improper accessories may be hazardous.
25. Maintain machinery with care. Follow instructions for lubricating and changing accessories.
26. Turn off the machine before cleaning. Use a brush or compressed air to remove dust or debris — do not use your hands.
27. Do not stand on the machine. Serious injury could occur if the machine tips over.
28. Never leave the machine running unattended. Turn the power off and do not leave the machine until it comes to a complete stop.
29. Never operate or run the machine without closing the drum up against the lid. Failure to do so will result in the machine amperage increasing and may trip your circuit.

Familiarize yourself with the following safety notices used in this manual:

SAFETY GUIDELINES - DEFINITIONS

This manual contains information that is important for you to know and understand. This information relates to protecting YOUR SAFETY and PREVENTING EQUIPMENT PROBLEMS. To help you recognize this information, we use the symbols below. Please read the manual and pay attention to these sections.



Indicates an imminently hazardous situation which, if not avoided, will result in death or serious injury.



Indicates a potentially hazardous situation which, if not avoided, could result in death or serious injury.



Indicates a potentially hazardous situation which, if not avoided, may result in minor or moderate injury.

LAGUNA

⚠ CAUTION

Indicates a potentially hazardous situation which, if not avoided, may result in minor or moderate injury.

⚠ CAUTION

Used without the safety alert symbol indicates potentially hazardous situation which, if not avoided, may result in property damage.

GENERAL SAFETY RULES

⚠ WARNING

WARNING FAILURE TO FOLLOW THESE RULES MAY RESULT IN SERIOUS PERSONAL INJURY.

FOR YOUR OWN SAFETY, READ AND UNDERSTAND THE INSTRUCTION MANUAL BEFORE OPERATING THE MACHINE. Learn the unit's application and limitations as well as the specific hazards peculiar to it.

KEEP WORK AREA CLEAN. Cluttered areas and benches invite accidents.

DON'T USE IN DANGEROUS ENVIRONMENT. Don't use this unit in damp or wet locations, or expose it to rain. Keep work area well-lighted.

KEEP CHILDREN AND VISITORS AWAY. All children and visitors should be kept a safe distance from work area.

DISCONNECT UNIT before servicing.

CHECK DAMAGED PARTS. Before further use of the unit, properly repair or replace any part that is damaged.

⚠ WARNING

FAILURE TO FOLLOW THESE RULES MAY RESULT IN SERIOUS INJURY.

ADDITIONAL SAFETY FOR DUST COLLECTORS

Intended use. This dust collector is only intended for collecting wood dust and chips from woodworking machines. Do not use this dust collector to collect metal, dirt, pebbles, drywall, asbestos, lead paint, silica, liquids, aerosols, or any flammable, combustible, or hazardous materials.



Hazardous dust. Dust created while using machinery may cause cancer, birth defects, or long-term respiratory damage. Be aware of dust hazards associated with each work piece material, and always wear a NIOSH-approved respirator to reduce your risk.

Dust allergies. Dust from certain woods may cause an allergic reaction in people and animals.

Make sure you know what type of wood dust you will be exposed to in case there is a possibility of an allergic reaction.

Wear respirator. Fine dust that is too small to be caught in the filter will be blown into the ambient air during operation. Always wear a NIOSH-approved respirator during operation and for a short time after to reduce your risk of permanent respiratory damage.

Emptying dust. When emptying dust from the collection container, wear a respirator and safety glasses. Empty dust away from ignition sources and into an approved container.

Disconnecting power supply. Turn the switch off, disconnect the dust collector from the power supply, and allow the impeller to come to a complete stop before leaving the machine unattended or doing any service, cleaning, maintenance, or adjustments.

Suspended dust particles and ignition sources. Do not operate the dust collector in areas where explosion risks are high. Areas of high risk include, but are not limited to, areas near pilot lights, open flames, or other ignition sources.

Fire suppression. Only operate the dust collector in locations that contain a fire suppression system or have a fire extinguisher nearby.

Impeller hazards. Do not place your hands or tools near the open inlet during operation for any reason. The powerful suction could easily cause accidental contact with the impeller, which will cause serious personal injury or damage to the machine. Always keep small animals and children away from open dust collection inlets.

Avoiding sparks. Do not allow steel or rocks to strike the impeller—this may produce sparks.

Sparks can smolder in wood dust for a long time before a fire is detected. If you accidentally cut

into wood containing tramp metal (nails, staples, spikes, etc.), immediately turn **off** the dust collector, disconnect it from power, and wait for the impeller to stop—then empty the collection container into an approved airtight metal container.

Operating location. To reduce respiratory exposure to fine dust, locate permanently installed dust collectors away from the working area, or in another room that is equipped with a smoke detector. Do not operate the dust collector in rainy or wet locations—exposure to water may create a shock hazard or decrease the life of the machine.

LAGUNA

Static electricity. Plastic dust lines generate high amounts of static electricity as dust chips pass through them. Although rare, sparks caused by static electricity can cause explosions or fire. To reduce this risk, make sure all dust lines are thoroughly grounded by using a grounding wire.

Regular cleaning. Regularly check/empty the collection bags or drum to avoid the buildup of fine dust that can increase the risk of fire. Make sure to regularly clean the surrounding area where the machine is operated—excessive dust buildup on overhead lights, heaters, electrical panels, or other heat sources will increase the risk of fire.

CAUTION

This means that if precautions are not heeded, it may result in minor injury and/or possible machine damage.

WARNING

This means that if precautions are not heeded, it may result in serious injury or possibly even death.

**SAVE THESE INSTRUCTIONS.
Refer to them often and use them to instruct others.**

LAGUNA

POWER CONNECTIONS

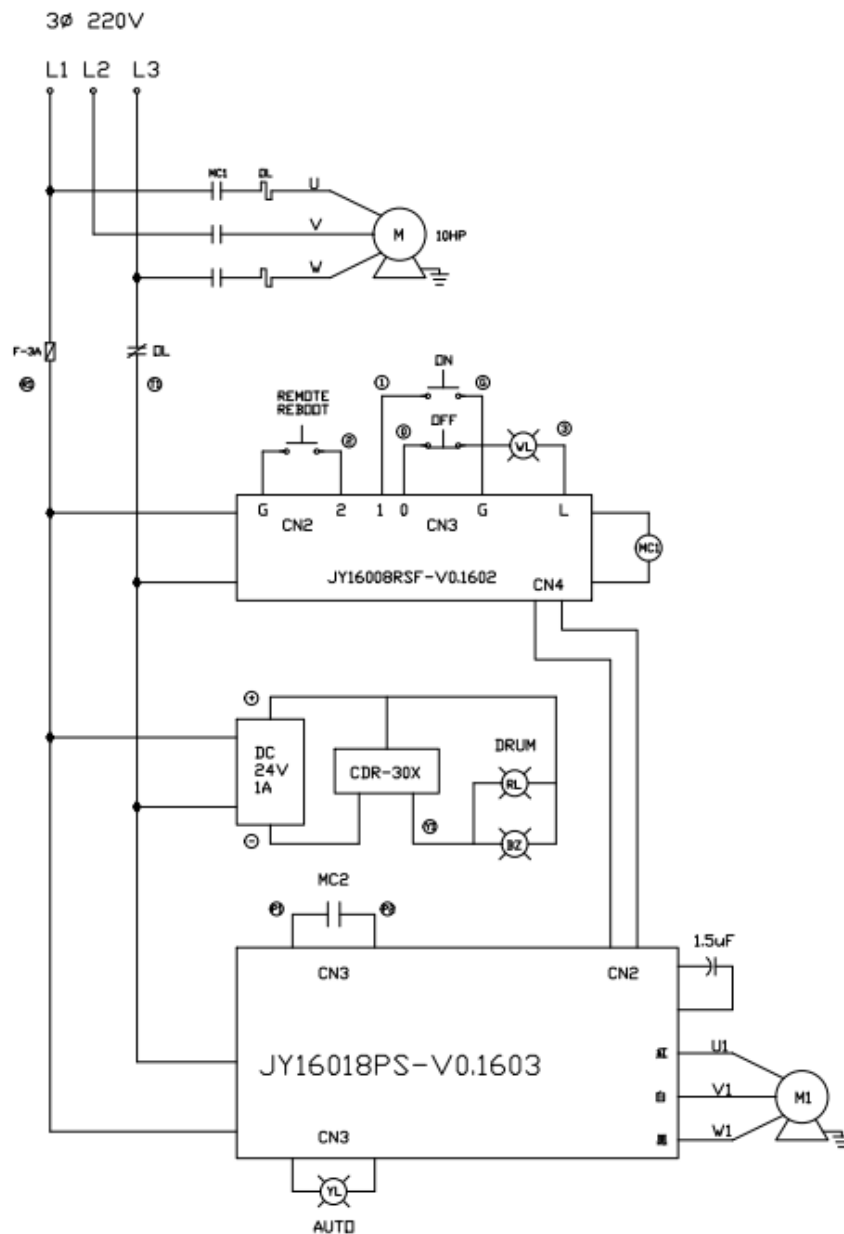

DO NOT EXPOSE THE MACHINE TO RAIN OR OPERATE THE MACHINE IN DAMP LOCATIONS.

MOTOR SPECIFICATIONS

Your machine is wired for 220 volts, 60 HZ alternating current. Before connecting the machine to the power source, make sure the switch is in the "OFF" position.

LAGUNA



DO NOT EXPOSE THE MACHINE TO RAIN OR OPERATE THE MACHINE IN DAMP LOCATIONS.

MOTOR SPECIFICATIONS

Your machine is wired for 220 volts, 60 HZ alternating current. Before connecting the machine to the power source, make sure the switch is in the "OFF" position.

GROUNDING INSTRUCTIONS



THIS MACHINE MUST BE GROUNDED WHILE IN USE TO PROTECT THE OPERATOR FROM ELECTRIC SHOCK.

1. This appliance must be connected to a grounded metal, permanent wiring system; or an equipment-grounding conductor must be run with the circuit conductors and connected to the equipment-grounding terminal or lead on the appliance.

The installer, such as a qualified electrician, cut (or bend over) and insulate the grounding conductor from a field wiring supply cable.

In the event of certain types of malfunctions or breakdowns, grounding provides a path of least resistance for electric current—in order to reduce the risk of electric shock.

Improper connection of the equipment-grounding wire can result in a risk of electric shock. The wire with green insulation (with or without yellow stripes) is the equipment-grounding wire. If repair or replacement of the power cord or plug is necessary, do not connect the equipment-grounding wire to a live (current carrying) terminal.

Check with a qualified electrician or service personnel if you do not understand these grounding requirements, or if you are in doubt about whether the tool is properly grounded. If you ever notice that a cord or plug is damaged or worn, disconnect it from power, and immediately replace it with a new one.

Full Load amperage Draw

Amp draw at 220V (prewired)..... 30 Amps

Power Supply Circuit Requirements

The power source circuit for your machine must be grounded and rated for the amperage given below. Never replace a circuit breaker on an existing circuit with one of higher amperage without consulting a qualified electrician to ensure compliance with wiring codes. **If you are unsure about the wiring codes in your area or you plan to connect your machine to a shared circuit, consult a qualified electrician.**

Circuit Size (220V)..... 50 Amps

LAGUNA

FUNCTION

High frequency remote control switch

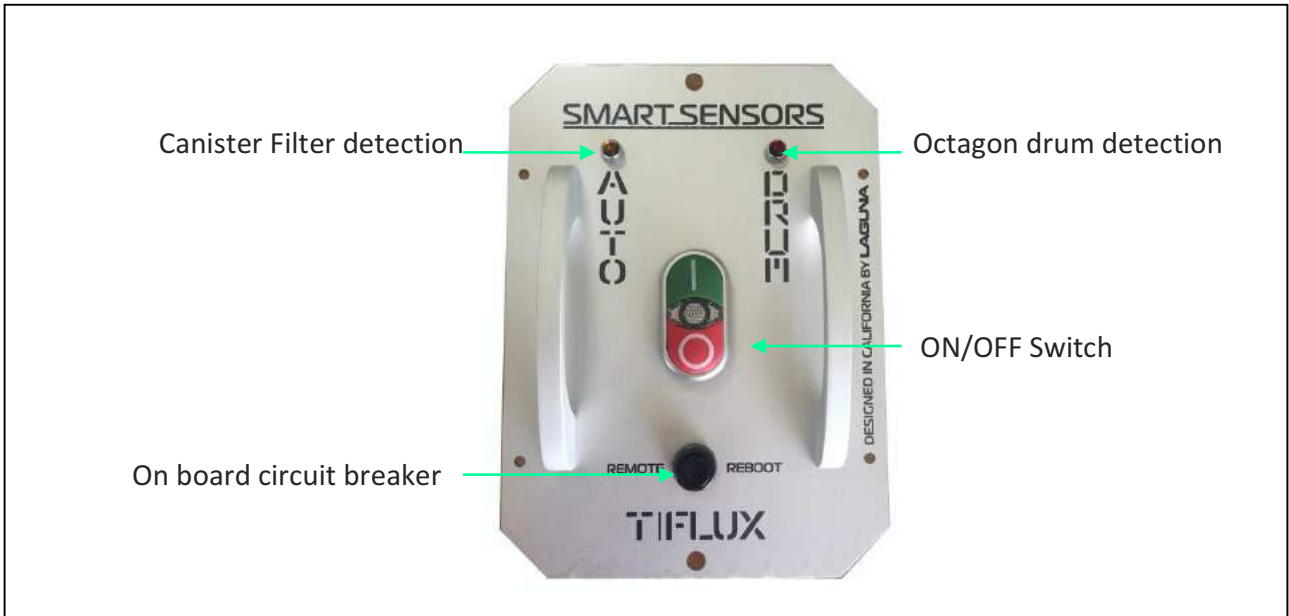

Hand held remote controller



This machine is programmed to clean the canister filter during operation every 10 minutes. It will clean for 10 seconds clockwise and another 10 seconds counterclockwise. When you switch OFF the unit, after 30 seconds when the fan comes to a complete stop, the canister filters will clean for 10 seconds clockwise and another 10 seconds counterclockwise.



PRODUCT SPECIFICATIONS

Motor Specs:	10 HP
Electrical Specs:	220V / 60Hz / 3PH / 3450 RPM
Running AMP	(with 12" inlet) 30A at 220V
Air Volume:	4030CFM (cubic feet per minute)
Max. static pressure	16.8 Inches of water
Fan size	18.5"
Inlet:	Ø12"
Switch	High frequency remote control switch
Collection capacity	54 gallon Octagon drum x 2sets
Packing Size: (L x W x H)	100.4" x 45.3" x 85.4" (255 x 115 x 217 cm)
Machine weight	1301 lbs (590 kgs)
Shipping weight	1621 lbs (735 kgs)

<u>Filter Media</u>	filtering area: 19.2m ² (207 ft ²)
Cartridge Filter	1 Micron Ø29.53" x 47.24" (Ø75 x 120cm) x 1pc

LAGUNA

UNPACKING

Your 10HP Stationary Dust Cyclone comes packed in a single wooden crate. Before attempting to assemble this machine, follow these directions for unpacking:

1. Carefully remove the wooden crate walls.
2. Carefully take out the machine components from the box and set aside.
3. Using the diagram below, ensure that all parts are present and in good condition.

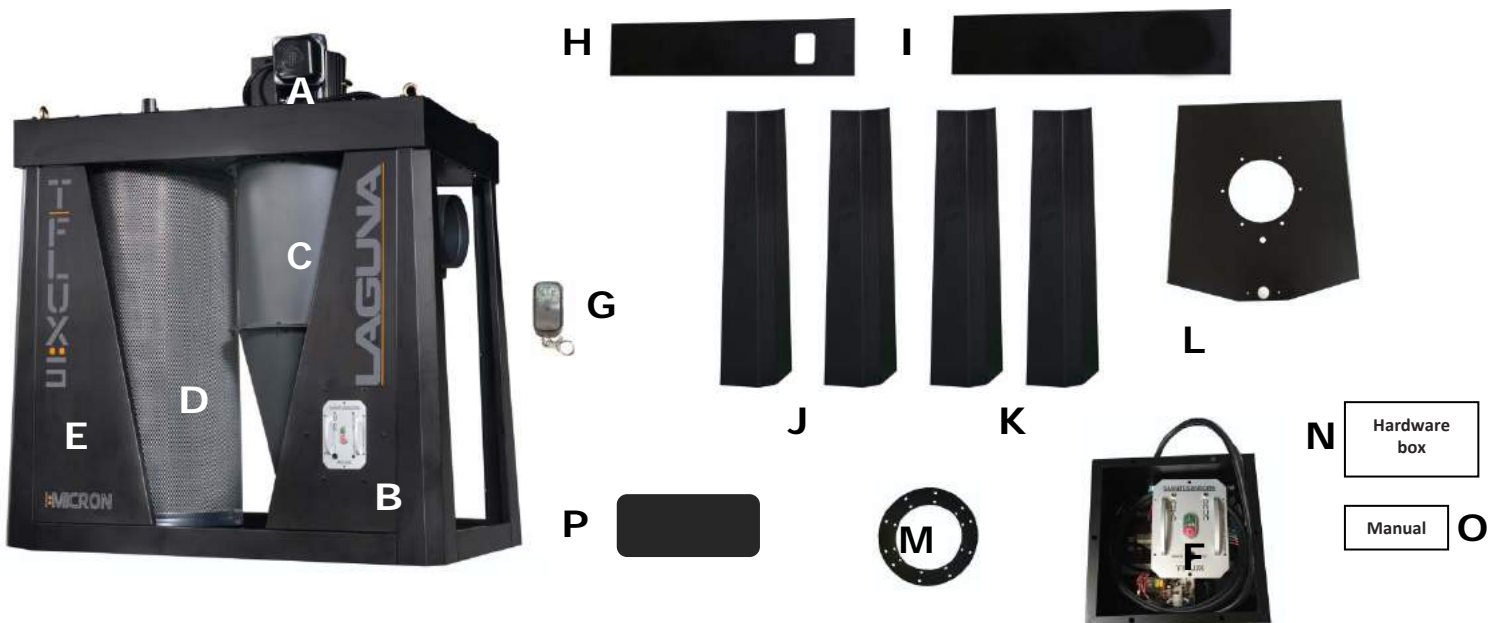

DESCRIPTION (QUANTITY) Figure 1

- | | |
|--------------------------------|----------------------------------|
| A. Motor | I. Back horizontal panel |
| B. Support panel | J. Lower upright support – right |
| C. Cyclone | K. Lower upright support – left |
| D. Canister filter | L. Drum lid |
| E. Support panel | M. Vacuum suction plate |
| F. Control panel and box | N. Hardware box |
| G. Hand held remote controller | O. Operating and Parts Manual |
| H. Front horizontal panel | P. Side horizontal panels |

Report any missing or damaged parts to your dealer or distributor. Prior to tool assembly and use, read this manual thoroughly to familiarize yourself with proper assembly, maintenance and safety procedures.

LAGUNA

GENERAL TOOL ASSEMBLY



This step requires two adults. This 10HP Stationary Dust Cyclone is heavy, be careful when lifting and handling it! Failure to comply may cause serious injury and/or damage to the machine and/or property!

Tools Required

10mm wrench / 12mm wrench / 14mm wrench

Phillips screwdriver

4mm hex wrench / 5mm hex wrench

To assemble your dust cyclone, follow these steps:

For your own safety, do not connect the machine to the power source until the machine is completely assembled. Please also make sure that you read and understand the entire instruction manual.

ASSEMBLY TIME ESTIMATE 1 hour to 2 hour

Step One: Use a forklift to lift the unit up by using a chain and hooking on end of the chain to the right top eye bolt; and the other side to the left top eye bolt. Slowly lift the unit up to a height where you will be able to assemble the lower upright supports.

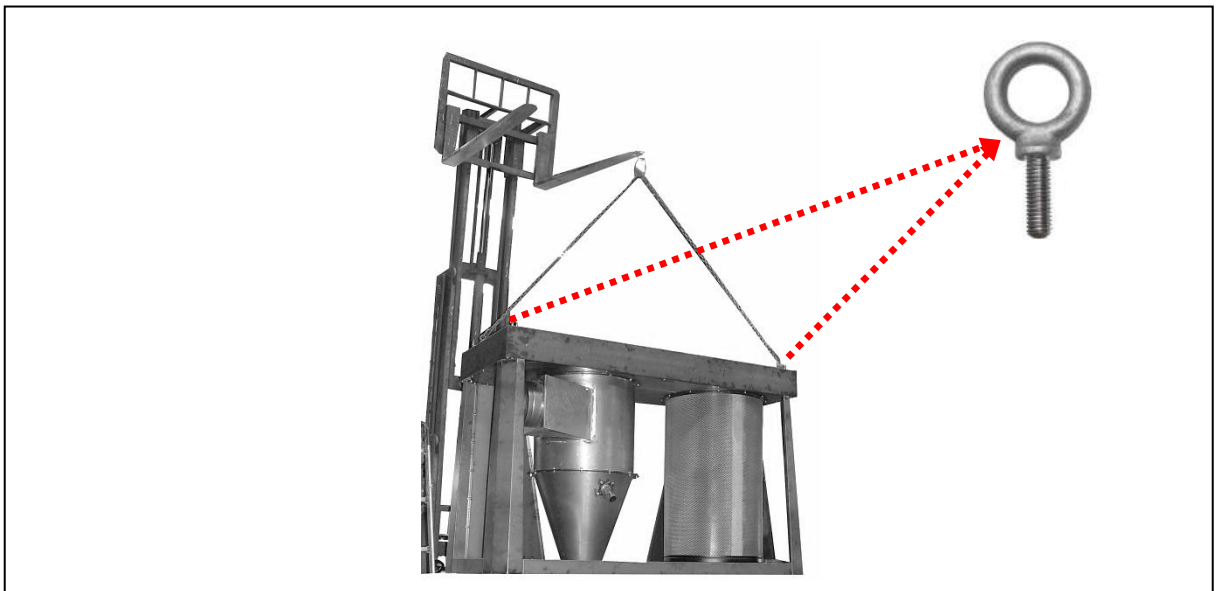

LAGUNA

Step Two: Secure the (2) lower upright supports to the right side of the machine when facing the control panel. These two lower upright supports have a one dot marking on the side rim, as shown below. Use (4) 3/8"×1" hex bolts and (8) 3/8"×OD23×2t flat washers and (8) 3/8" lock nuts for the two side bolt holes.

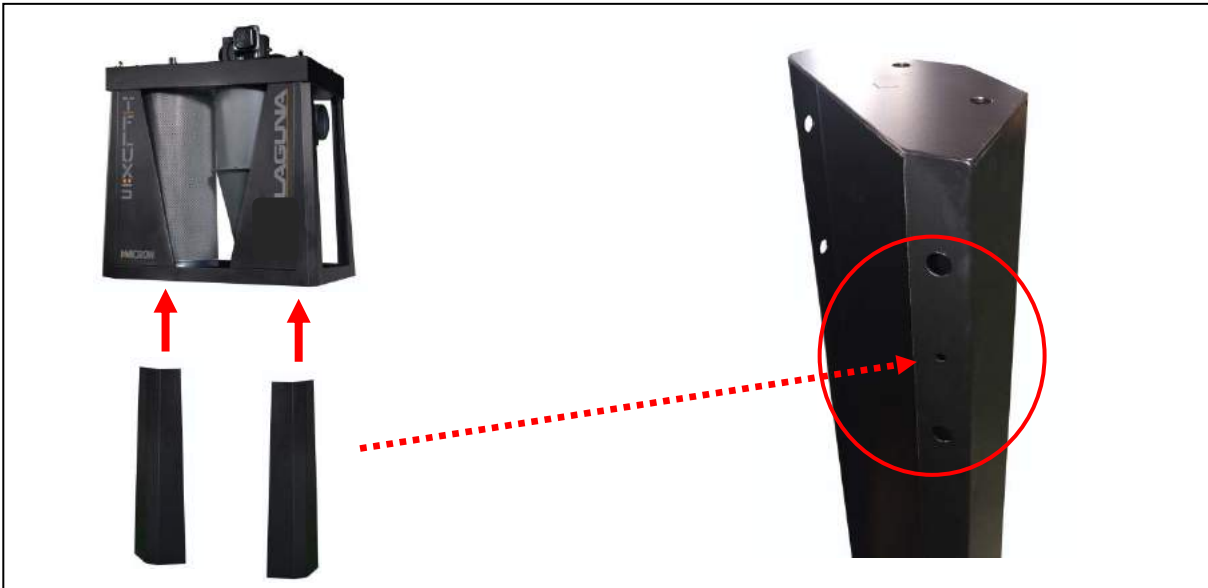

Step Three: Secure the (2) lower upright supports to the right side of the machine when facing the control panel. These two lower upright supports have a two dot marking on the side rim, as shown below. Use (4) 3/8"×1" hex bolts and (8) 3/8"×OD23×2t flat washers and (8) 3/8" lock nuts for the two side bolt holes and use (1) M16×50mm hex bolt for the center bolt.

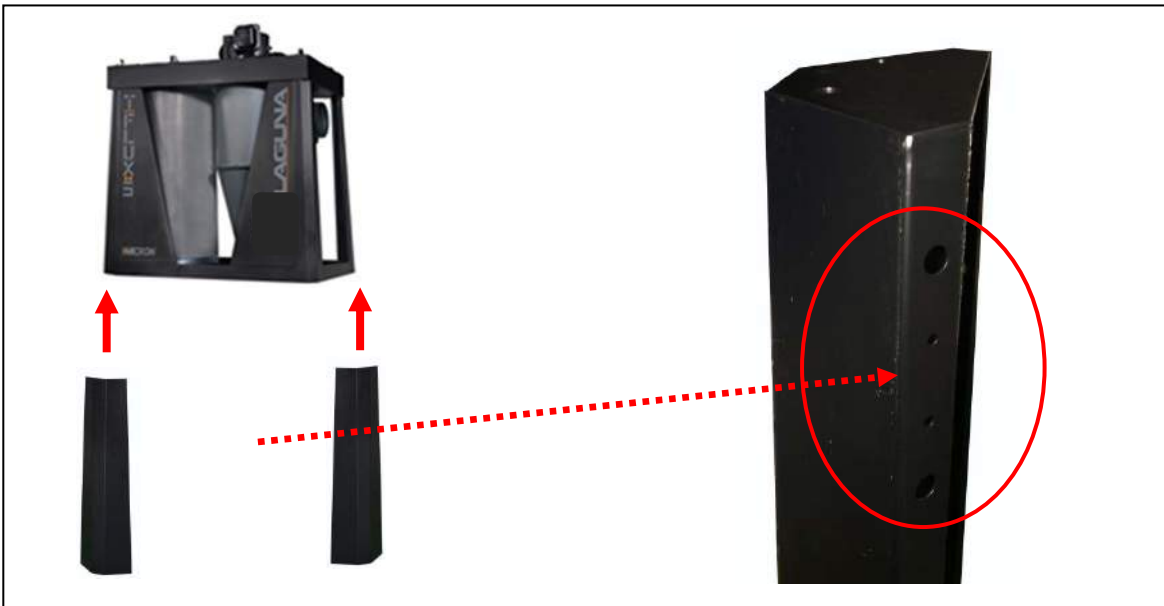

LAGUNA

Step Four: Secure the front horizontal panel with the opening for the control panel to the front of the unit; facing the control side. Use (12) 3/8"*1" hex bolts, (24) 3/8"*OD23*2t flat washers and (12) 3/8" lock nuts.

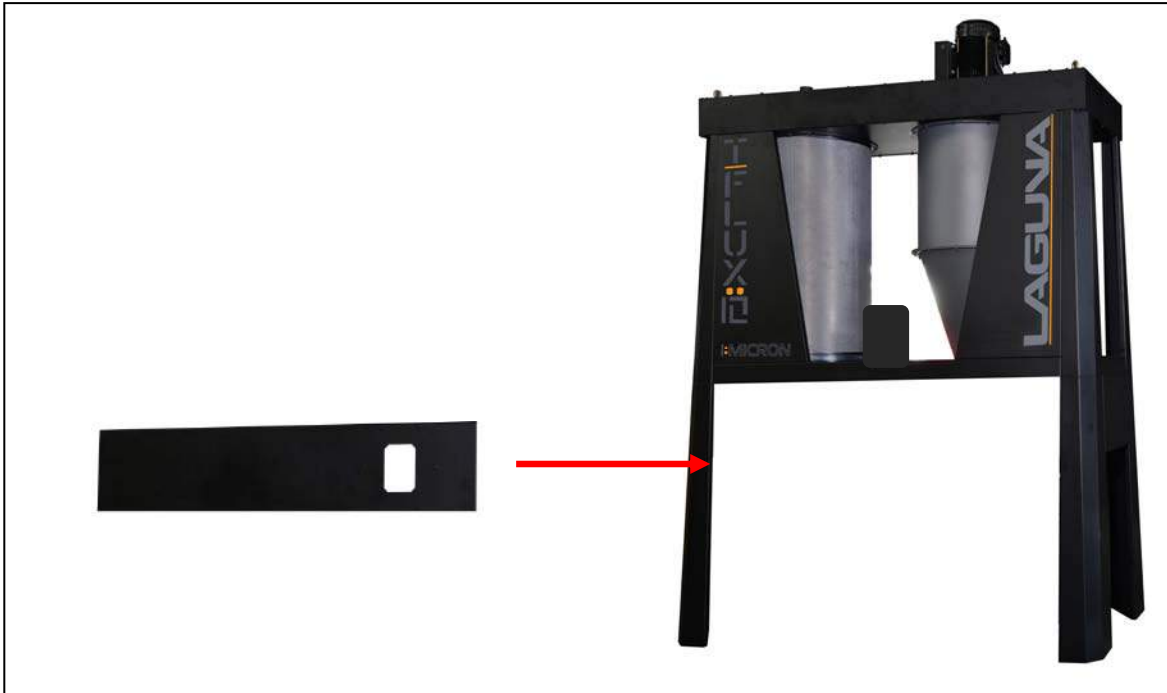

Step Five: Secure the back horizontal panel with the opening for the control panel to the front of the unit; facing the control side. Use (12) 3/8"*1" hex bolts, (24) 3/8"*OD23*2t flat washers and (12) 3/8" lock nuts.



LAGUNA

Step Six: Secure the side horizontal panel to the right side of the unit; facing the control side. Use (12) 3/8"×1" hex bolts, (24) 3/8"×OD23×2t flat washers and (12) 3/8" lock nuts.



Step Seven: Secure the side horizontal panel to the left side of the unit; facing the control side. Use (12) 3/8"×1" hex bolts, (24) 3/8"×OD23×2t flat washers and (12) 3/8" lock nuts.



LAGUNA

Step Eight: Take the vacuum suction tube connector and attach to the horizontal back panel using (4) 1/4" * 3/4" hex bolts and (4) 1/4" * OD19 * 2t flat washers.

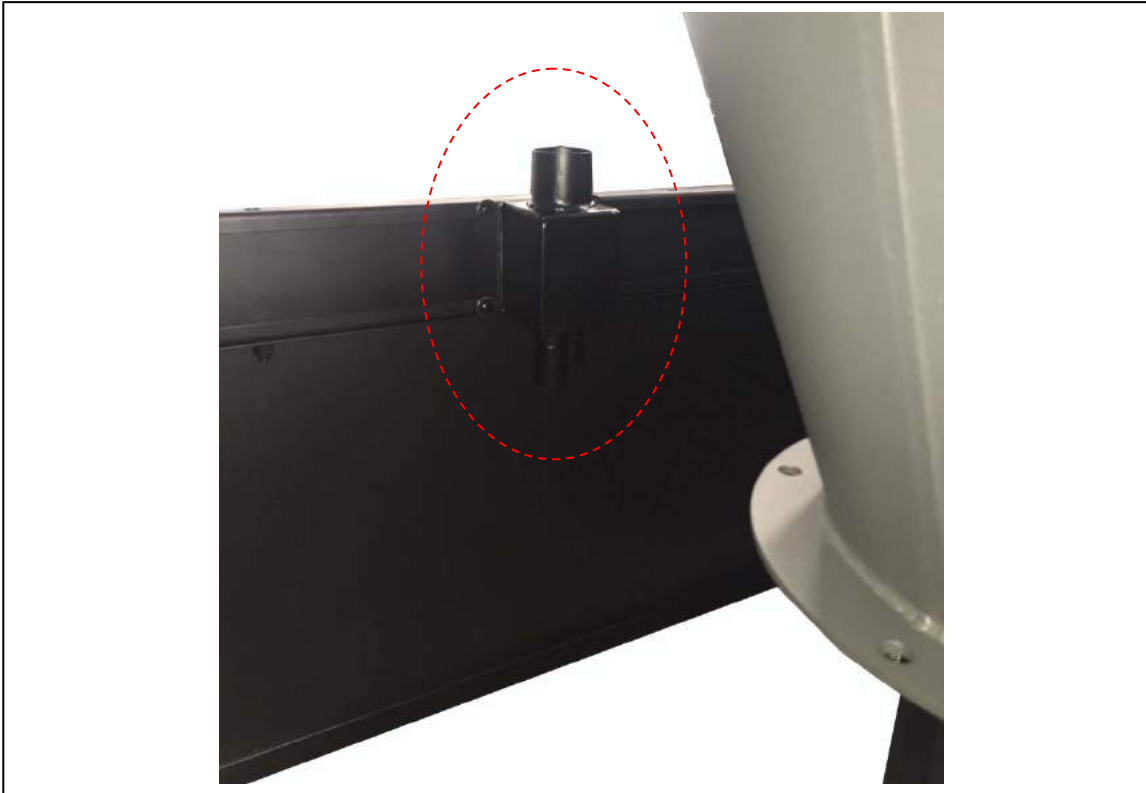

Step Nine: Take the drum lid vacuum suction tube and attach to the drum lid using (2) 1/4" * 3/4" hex bolts and (2) 1/4" * OD19 * 2t flat washers.

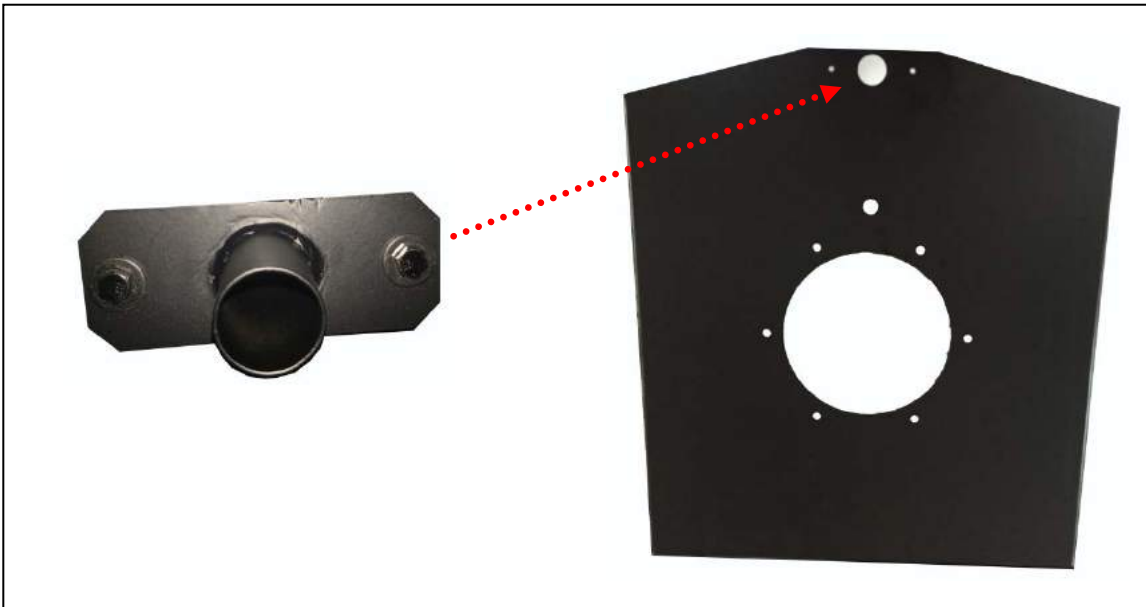

LAGUNA

Step Ten: Attach the one end of the black flex hose to the vacuum tube on the cyclone funnel and the other end to the top end of the vacuum suction tube connector. Secure and fix the flex hose with the hose clamps.

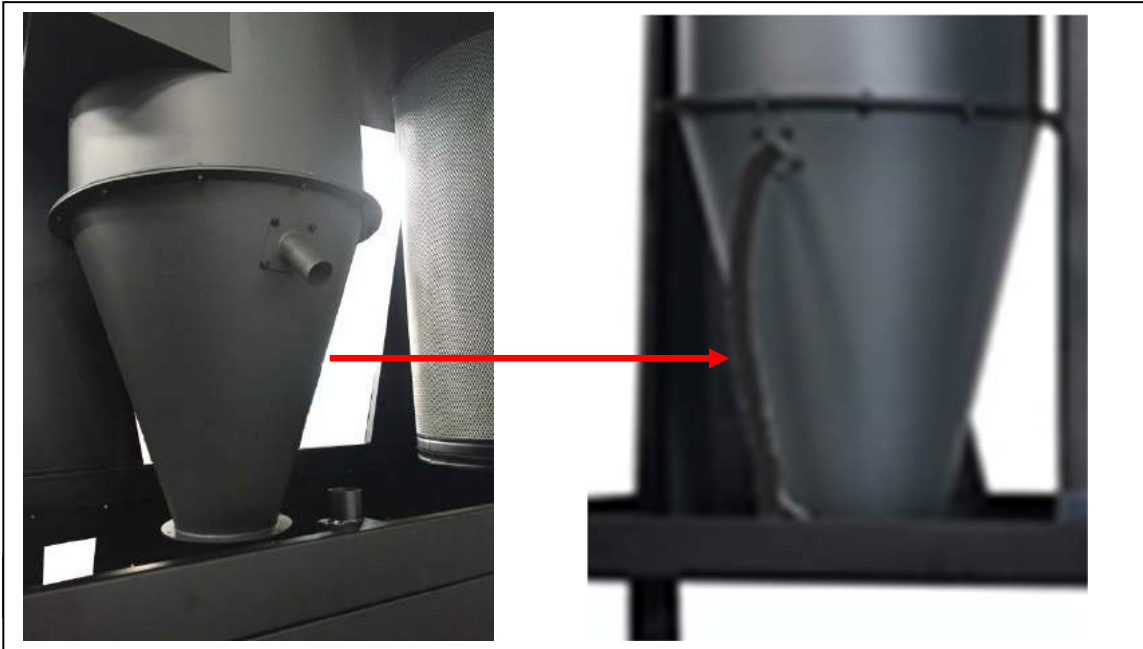

Step Eleven: Take the drum lid and apply the 3*6mm foam tape provided to two square center openings. Go along the inner ring and avoid covering the bolt holes.

Make sure that the end with the vacuum suction tube is facing the back, away from the control panel side.

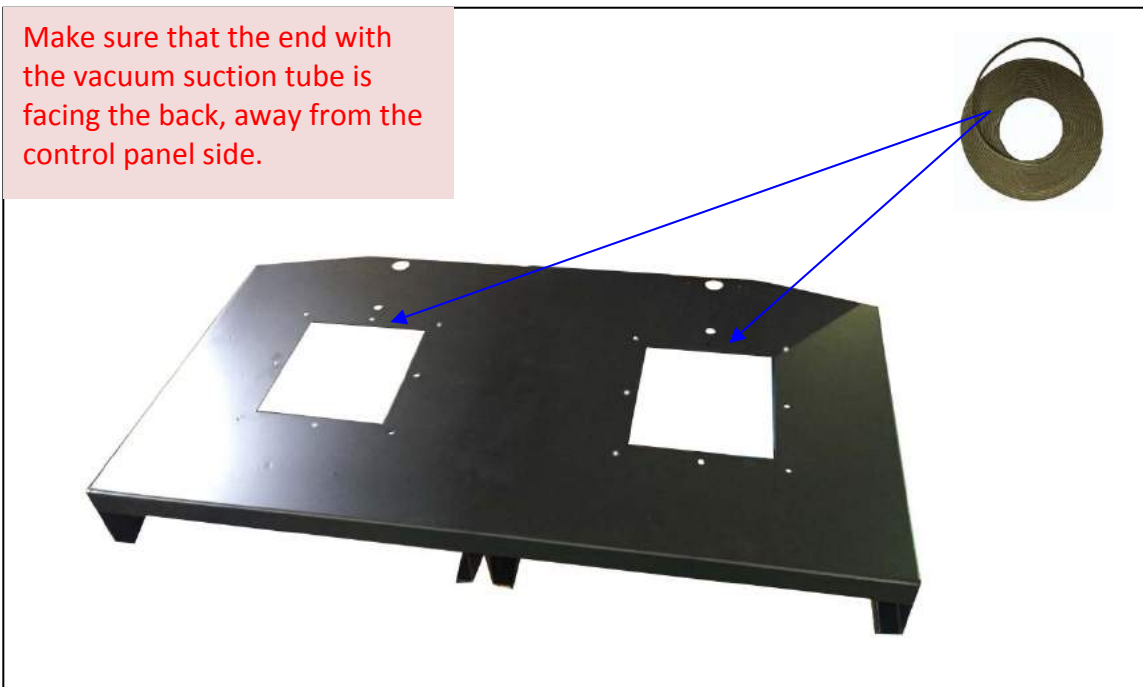

LAGUNA

Step Twelve: Attach the lower connector to the drum lid using (16) 3/8"×1" hex bolts and (32) 3/8"×OD23×2T flat washers



Step Thirteen: Place the flange on top of the connector.



LAGUNA

Step Fourteen: Carefully lift the drum lid and connector using a fork lift and move under the cyclone funnel. Attach the connector to the cyclone funnel using (6) 5/16" * 1-1/4" hex bolts and (12) 5/16" * OD18 * 2t flat washers.

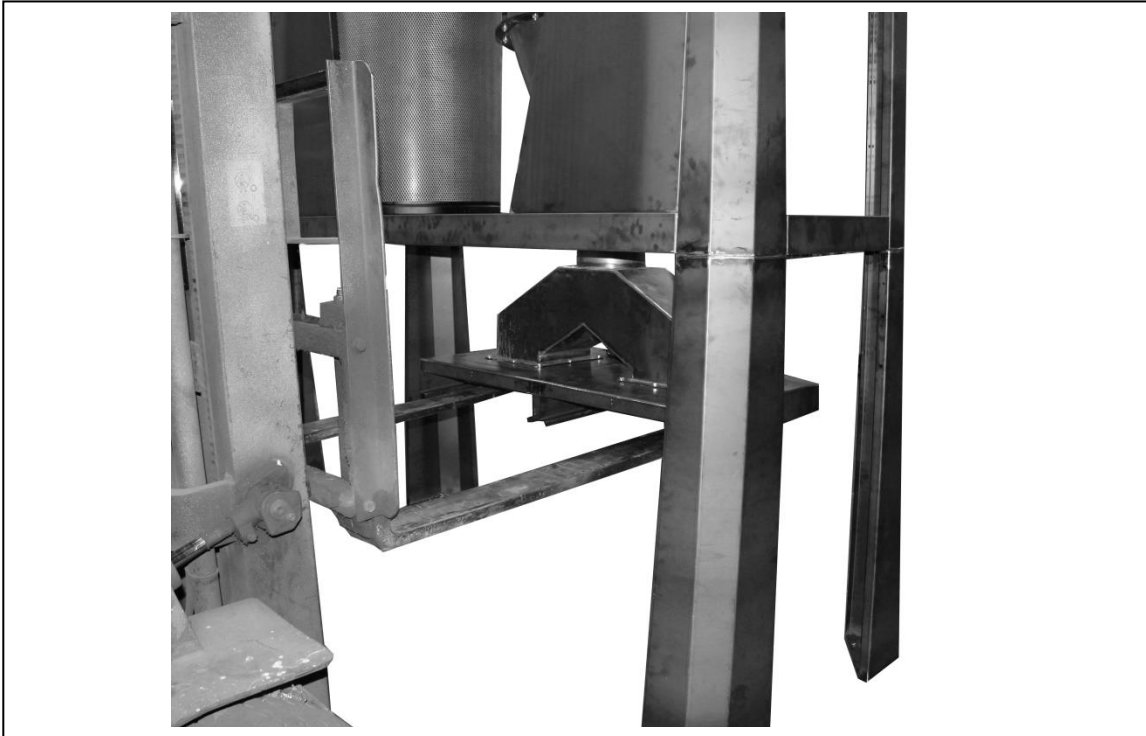

Step Fifteen: Secure the latch base plate to the front side of the drum lid using (2) 3/16" * 3/8" round head bolts.



LAGUNA

Step Sixteen: Take the proximity sensor and cord leading from the control box and assemble to the top of the drum lid.



Step Seventeen: First remove one of the black screws off the sensor then thread the sensor through the hole on the drum lid. Take the black screw and tighten the other end of the sensor that is on the inner side of the lid.



Step Eighteen: Make sure that the proximity sensor is not thread in too deeply into the drum lid. As this will create interference when the drum is inserted and may hit the proximity sensor creating damage.



LAGUNA

Step Nineteen: To adjust the distance of the sensor to detect the dust waste level use the white plastic pin that was provided in the hardware box.

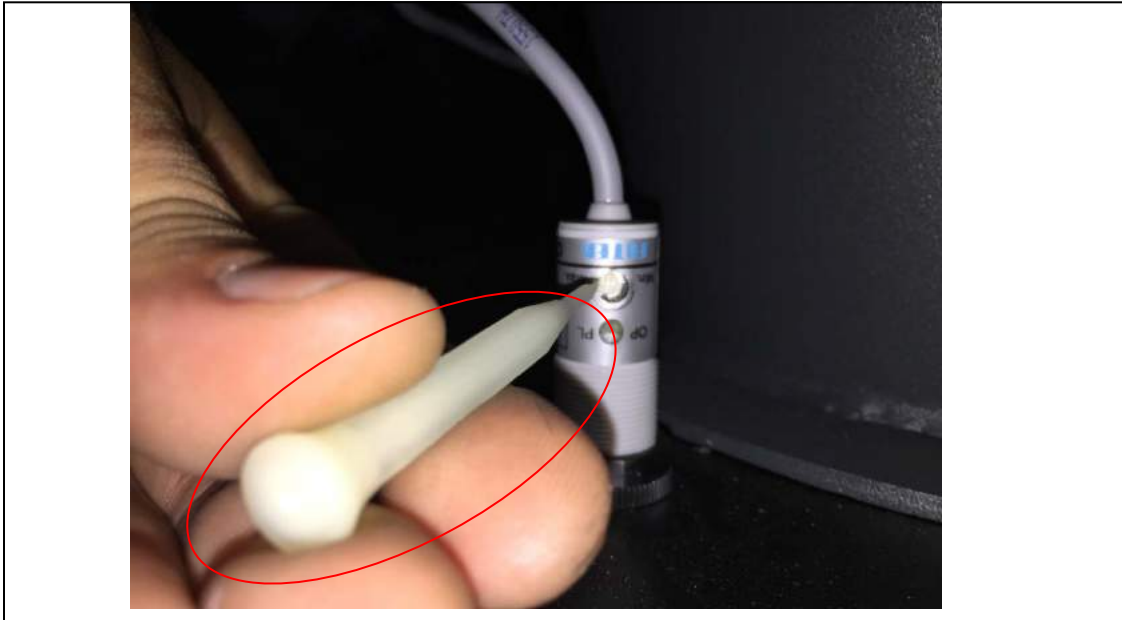

Step Twenty: Using the white plastic pin, insert the sharp point into the top end of the proximity sensor that is on top of the drum lid. You will find a small hole to on top where you can turn clockwise or anti-clockwise.

※Clockwise: Lower dust waste level in drum (Less full drum)

※Anti-clockwise: Higher dust waste level in drum (Fuller drum)



LAGUNA

Step Twenty One: Secure the casters to the drum base panel using (8) 3/8"*OD23*2T flat washers and (4) 3/8" nuts.



Step Twenty Two: Assemble the front and back panel to the drum base using (10) 5/16"*5/8" Philip hd bolts, (20) 5/16"*OD18*2t flat washers and (10) 5/16" nuts.



LAGUNA

Step Twenty Three: Assemble the side panels to the drum using (6) 5/16"×5/8" Philip hd bolts, (12) 5/16"×OD18*2t flat washers and (6) 5/16" nuts to secure the base. And then use (16) 5/16"×5/8" Philip hd bolts, (16) 5/16"×OD18*2t flat washers and (16) 5/16" nuts to secure the panels to each other.



Step Twenty Four: Assemble the top rim to the panels using (11) 5/16"×5/8" Philip hd bolts, (11) 5/16"×OD18*2t flat washers and (11) 5/16" nuts.



LAGUNA

Step Twenty Five: Assemble the latch to the drum using (4) 3/16"×3/8" round head thread bolts.

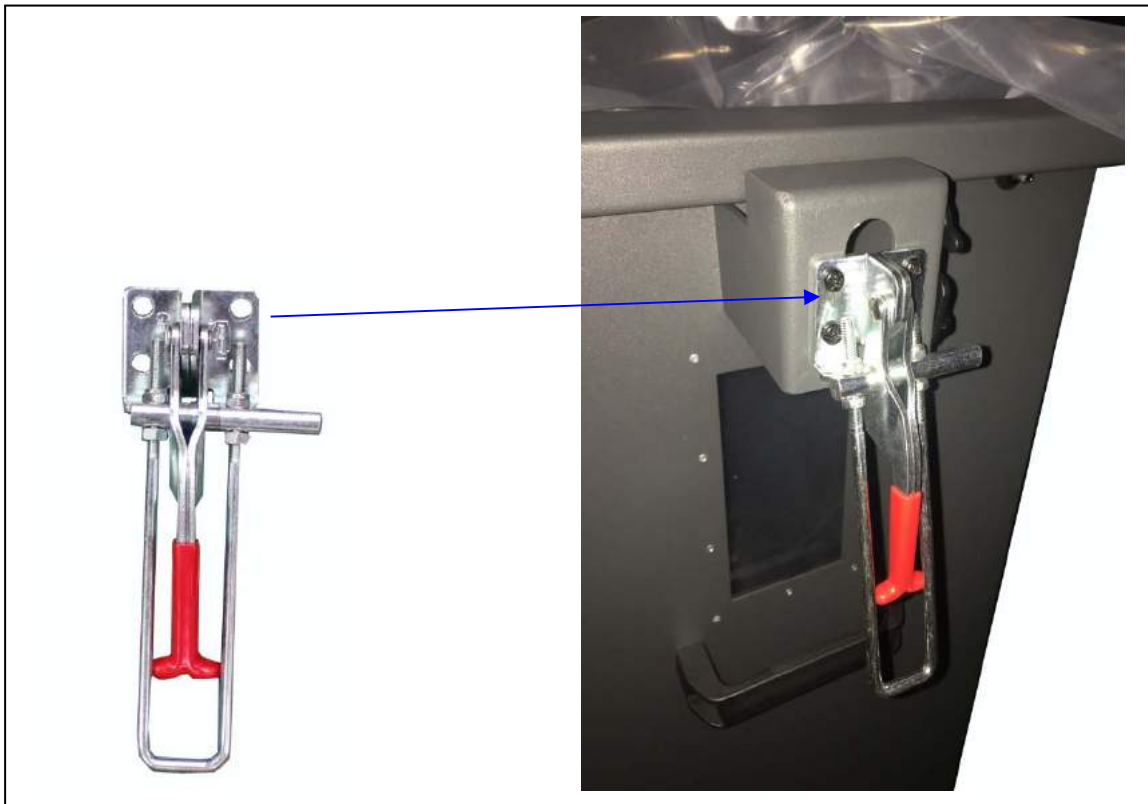

Step Twenty Six: Assemble the drum vacuum suction tube to the back panel using (4) 5/16"×3/4" hex bolts and (8) 5/16"×OD18*2T flat washers.



LAGUNA

Step Twenty Seven: Attach the $\text{\O}1\text{-}1/4\text{'}$ x0.8M black flex hose to the drum vacuum suction tube and use the $\text{\O}1\text{-}1/4\text{'}$ hose clamp to tighten and secure the black flex hose in place.



Step Twenty Eight: Attach the other end of the $\text{\O}1\text{-}1/4\text{'}$ x0.8M black flex hose to the drum lid vacuum suction tube and use the $\text{\O}1\text{-}1/4\text{'}$ hose clamp to tighten and secure the black flex hose in place.



LAGUNA

Step Twenty Nine: Place the vacuum suction ring inside before inserting the plastic bag in the Octagon drum.

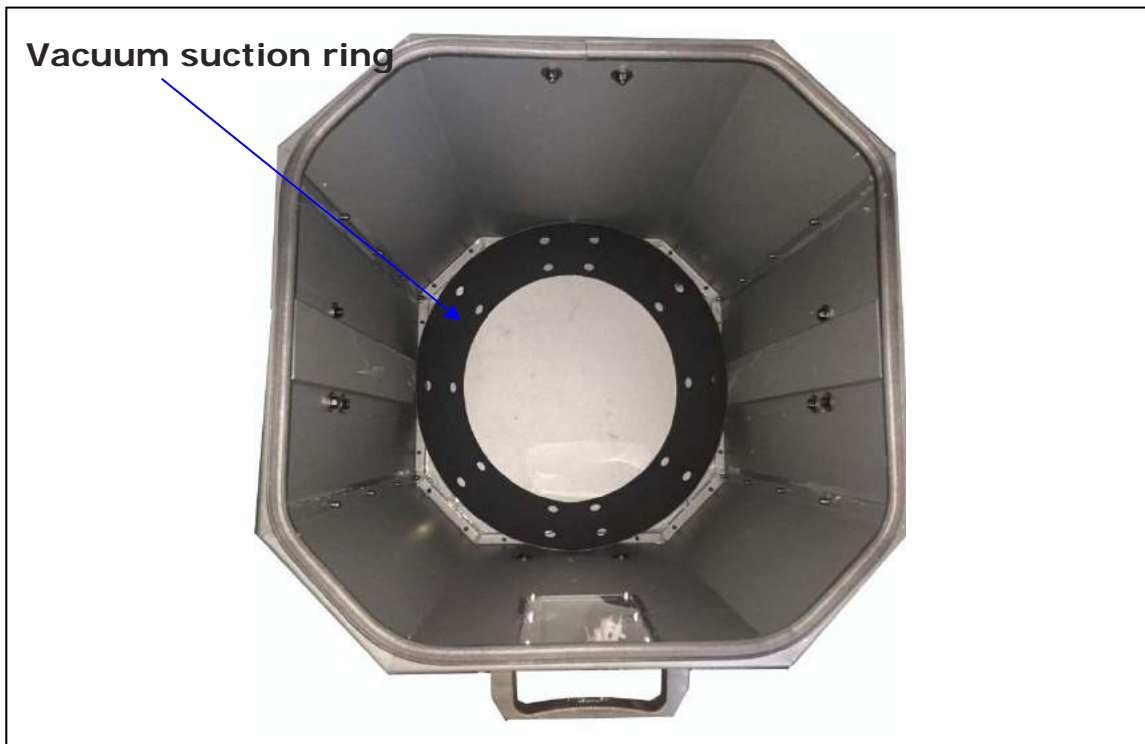

Step Thirty: Once completing the assembly, apply silicone to the inside of the drum including the base to seal and prevent air leakages.

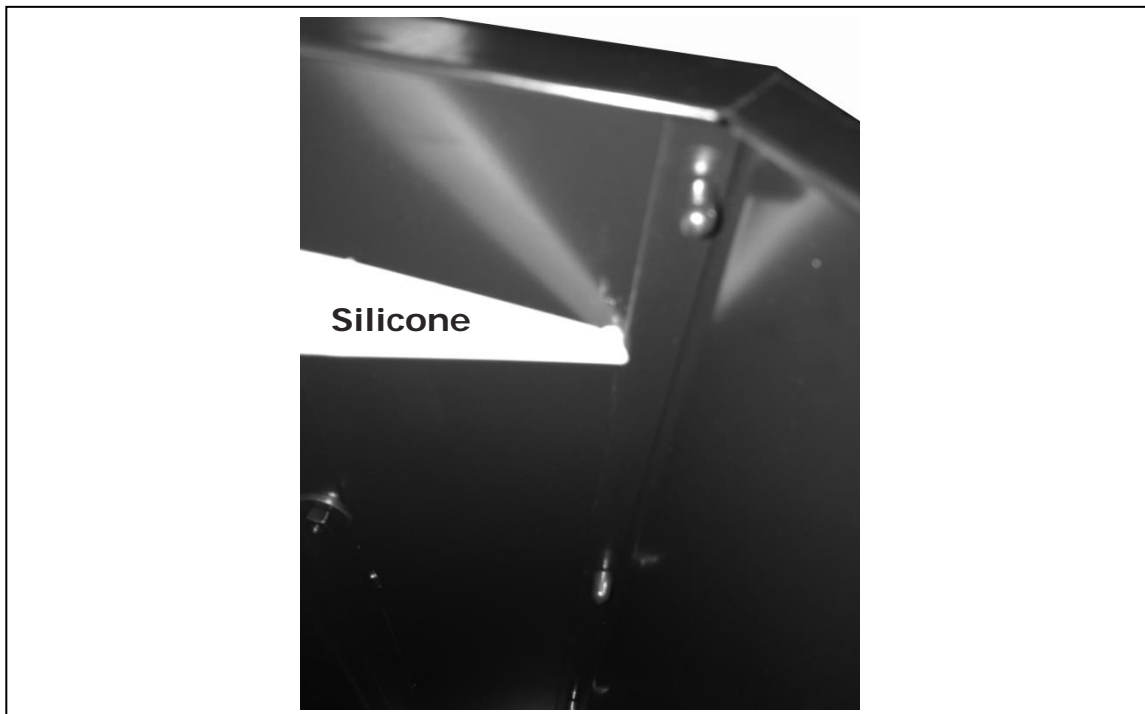

LAGUNA

Step Thirty One: Punch out a hole in the control panel next to where the motor cord is located. Refer to circled area in the location shown below



Step Thirty Two: Thread the power cord through the hole in the control box and connect to L1 and L2 terminal.

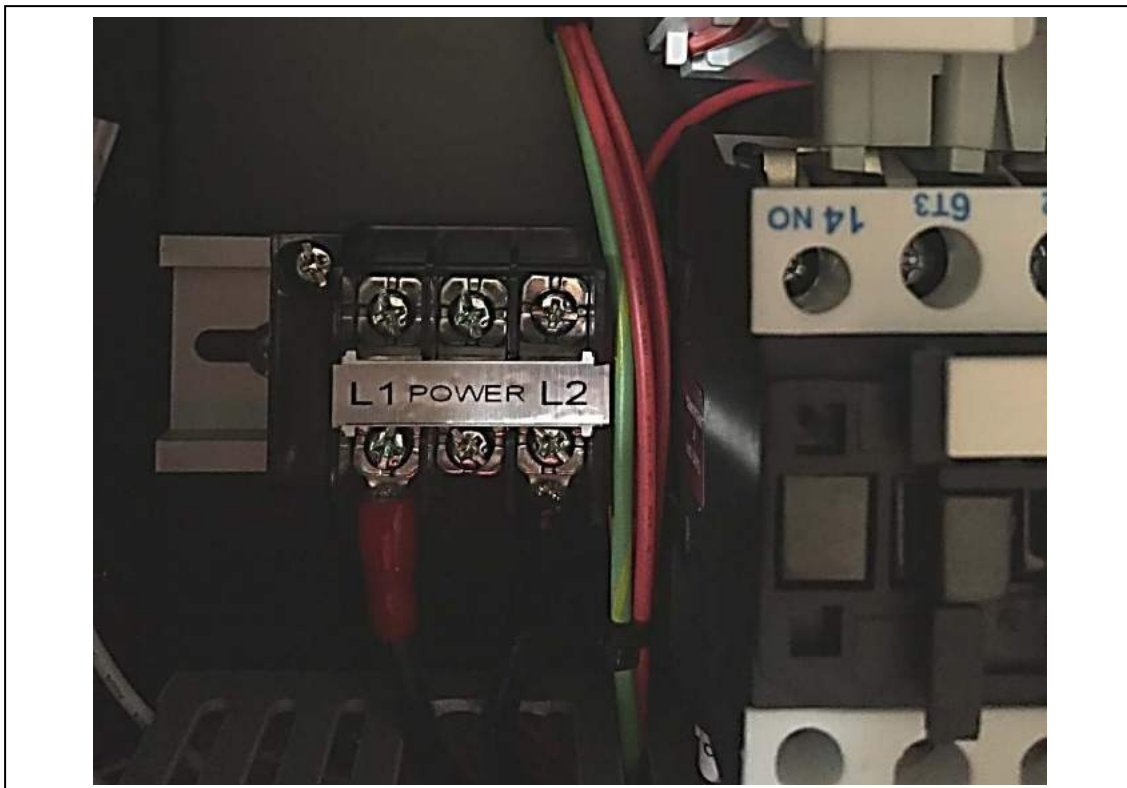

LAGUNA

Step Thirty Three: Take the control box provided and attach to the front horizontal panel.

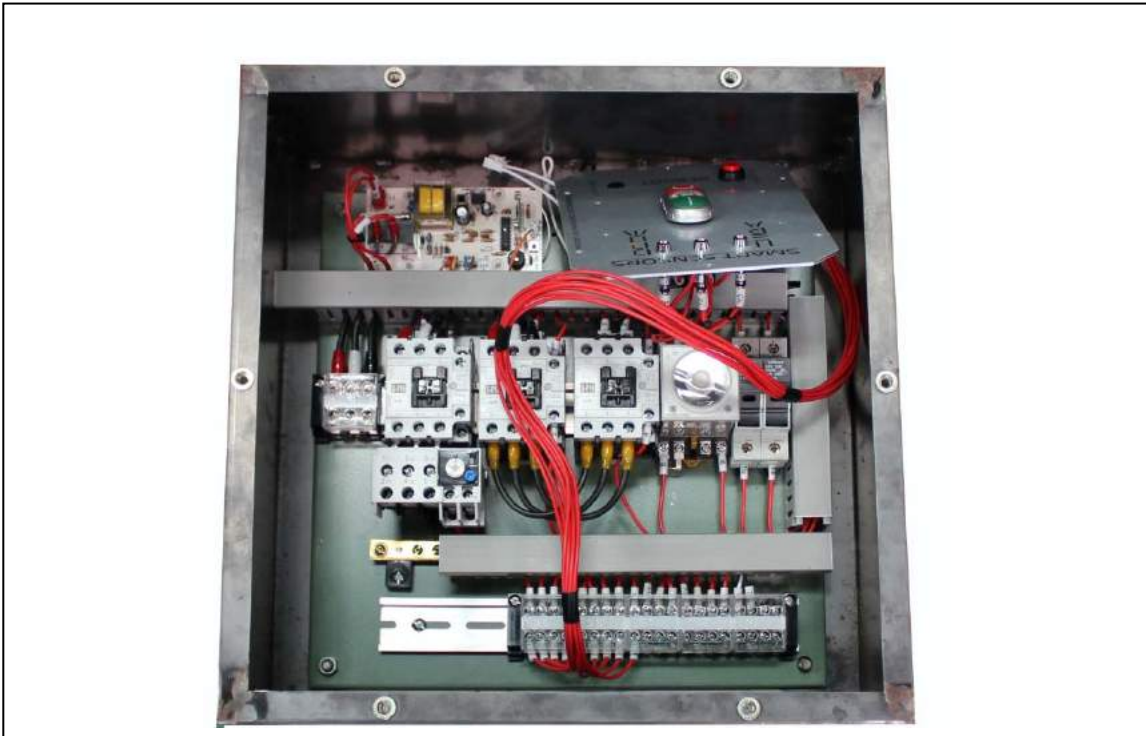

Step Thirty Four: Position the control box behind the front horizontal panel and let it rest on the drum lid.

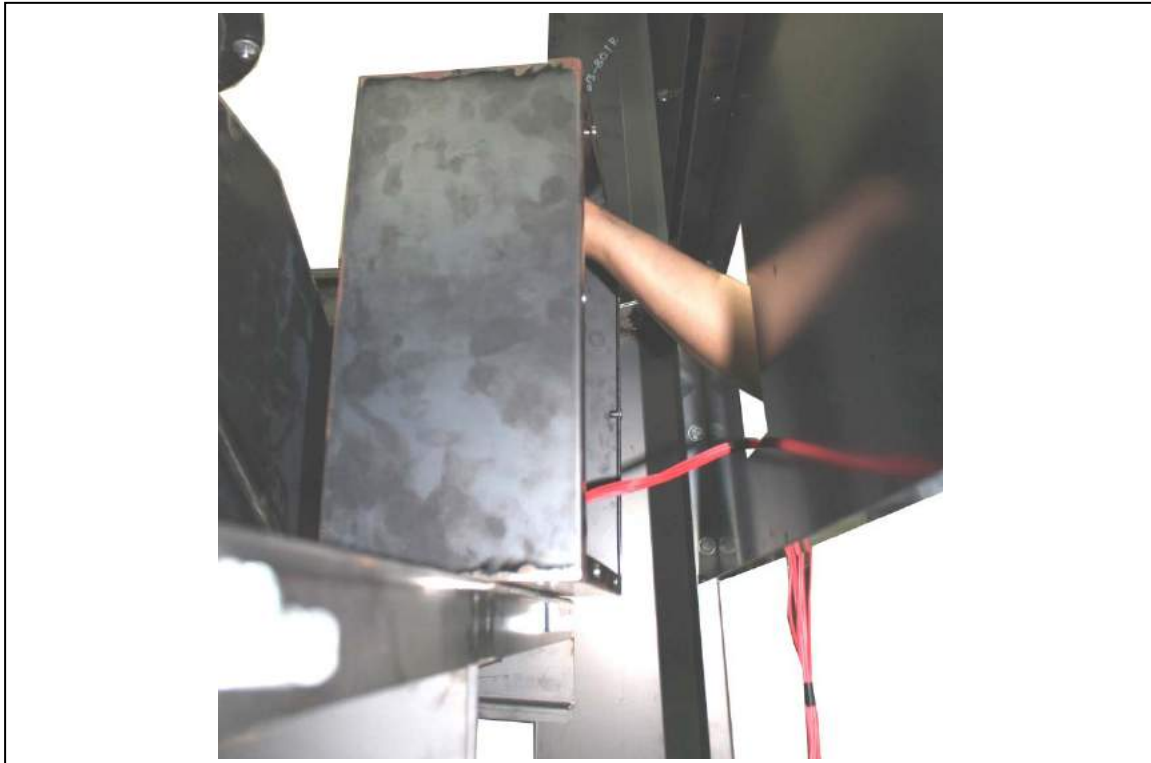

LAGUNA

Step Thirty Five: Before bolting on the control box, you must first take out the control panel from the box and insert through the hole on the horizontal panel.

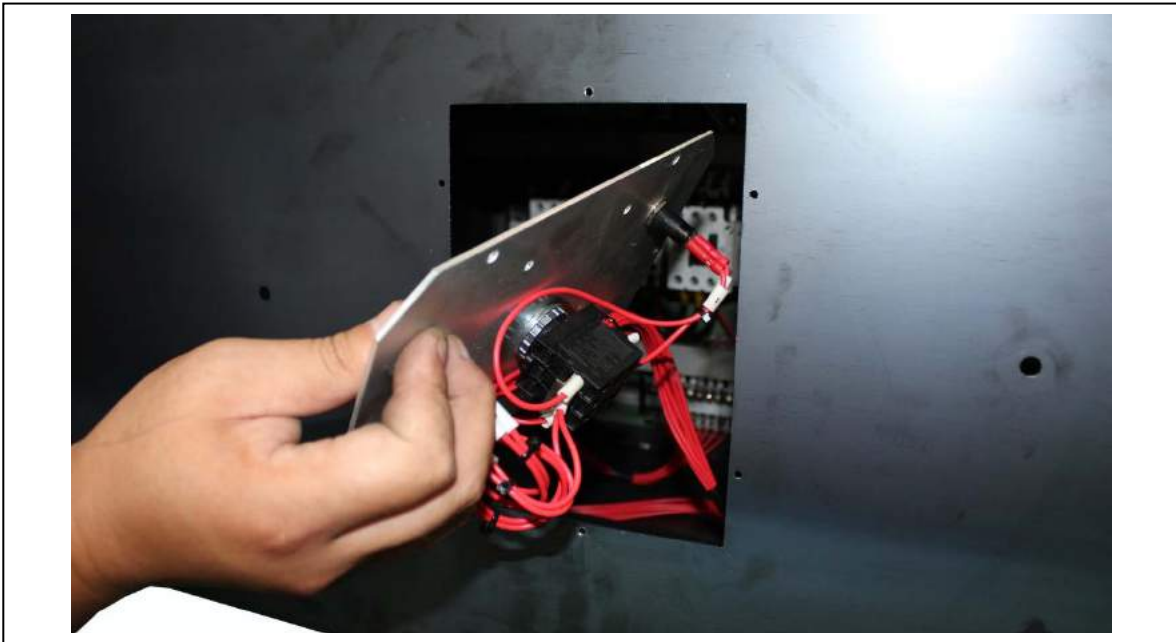

Step Thirty Six: Secure the control panel from the side panel using (6) 3/16" x 3/8" round head bolts.



LAGUNA

Step Thirty Seven: All the assembly steps have been completed..



CLEANING THE FILTER

To ensure proper operation of this Dust Cyclone, the canister filter must have adequate air flow. This means the filter must be regularly maintained by carefully blowing the filter clean using compressed air and an air gun to release built-up particulates trapped between the filter pleats.

For heavy duty users, it is recommended to use compressed air on a regular basis to maintain maximum filtration efficiency and longer life span of the filter.

Auto cleaning motor

The machine is equipped with an auto cleaning system that will clean the canister filter in an hourly interval for 10 seconds one way and another 10 seconds the other way. The cleaning will stop when you shut the machine off. While the canister is cleaning the LED light will illuminate showing that it is in the process of cleaning.

Using Compressed Air



DISCONNECT MACHINE FROM POWER!

For heavy duty users, it is recommended to use compressed air on a weekly basis to maintain maximum filtration efficiency and longer life span of the filter.

REMOVING THE CANISTER FILTER

1. Open the maintenance door on the canister cover plate sitting on top of the dust chute where the gear motor is located.

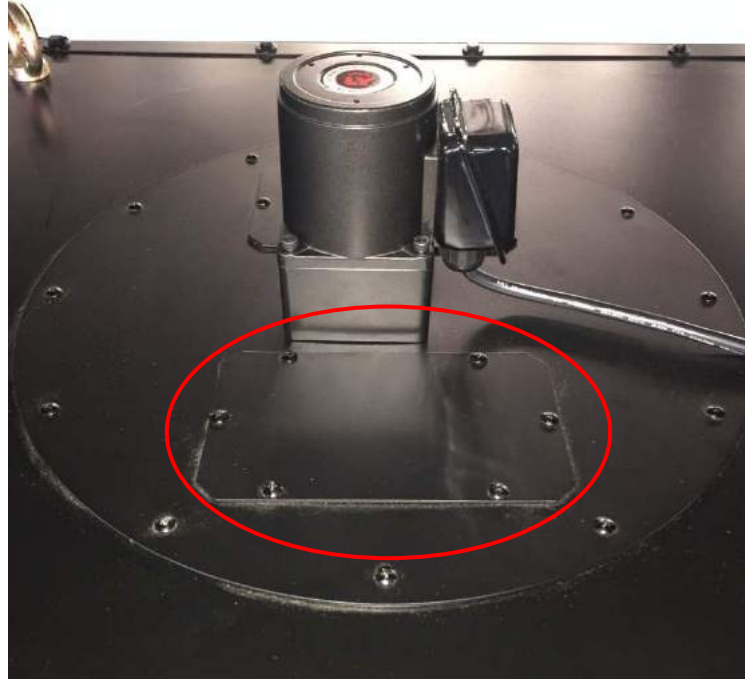

2. Loosen the bolt off of the rotation shaft as shown below. Set the shaft aside for later use. Keep the bolt for use when reassembling the rotation shaft.

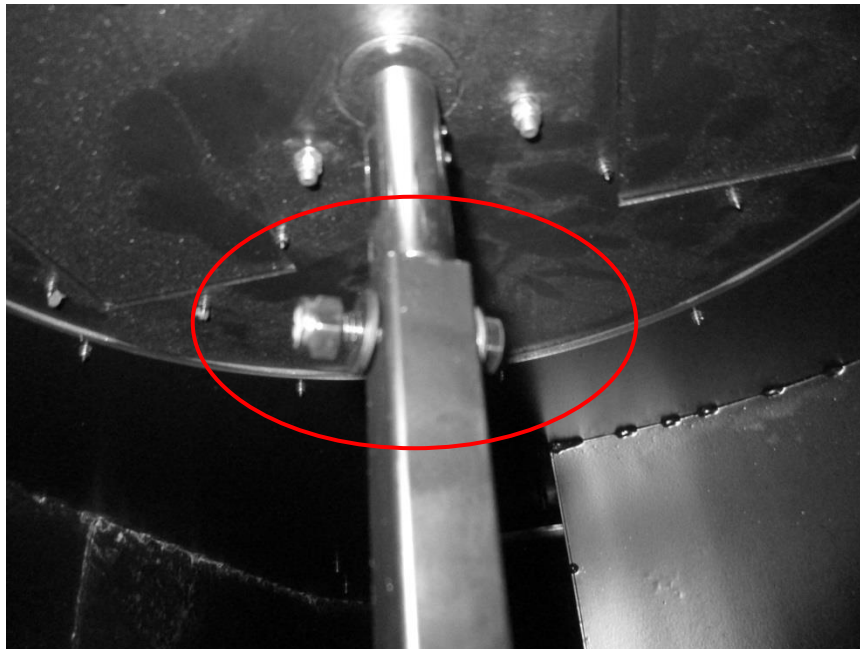

LAGUNA

3. With the help of another person, loosen the 12 bolts holding the canister filter to the dust chute. Carefully remove the canister filter off from the dust chute.



4. With the canister filter removed use a compressed air gun to thoroughly clean between the pleats, both inside and outside.

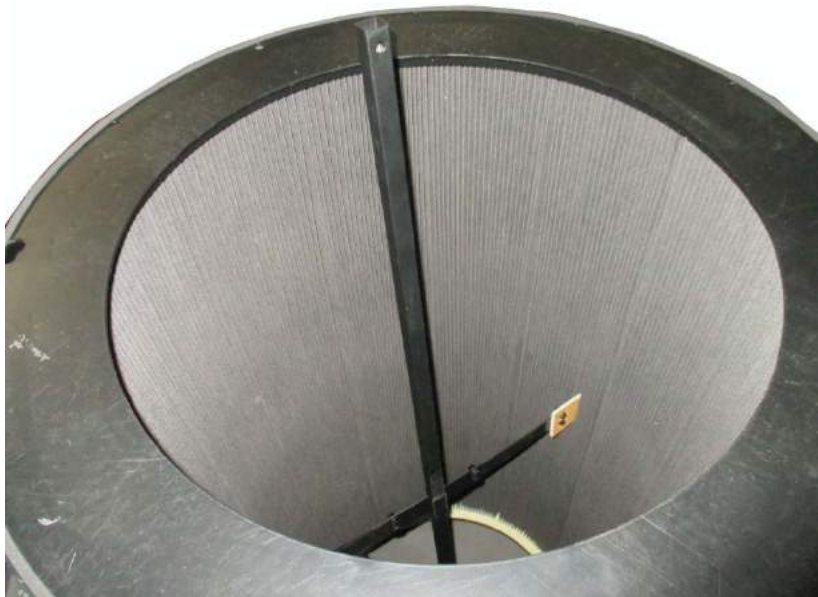

LAGUNA

RE-ASSEMBLING THE CANISTER FILTER AFTER CLEANING

1. With the aid of another person, carefully re-insert the canister filter repeating steps above in reverse.

EMPTYING OR REPLACING THE FILTER BAG

Periodically check the filter bag, if it is more than one third full, it is recommended that you empty it.

NOTE: If the filter bag gets too full, the weight may force it to pull away from the band clamp, exposing the user to potentially harmful particulates.

1. Release the spring-loaded band clamp at the bottom of the filter and remove the filter bag.
2. Empty or replace the filter bag and re-attach using the spring-loaded band clamp.

EMPTYING THE DRUM

Periodically inspect the contents of the drum and empty as needed. To inspect the contents of the drum:

1. Lift the red hand on the latch on the drum lid to lower the drum.



2. Roll it away from the machine, inspect and empty as needed.

ROUTINE INSPECTION

It is a good idea to routinely inspect any quality woodworking tool in order to keep it in optimum condition. This includes inspecting all hardware for tightness, ensuring the filter is clean, and cleaning debris and grime from any surfaces and moving parts.



TROUBLESHOOTING GUIDE

Symptom	Possible Cause	Possible Solution
Machine does not start or a breaker trips.	Power supply switched OFF or is faulty.	Ensure power supply is ON and has the correct voltage.
	Wall fuse/circuit breaker is blown/tripped.	Ensure adequate circuit size; install inlet restrictor, replace weak breaker.
	Faulty remote control.	Replace batteries; ensure unobstructed line-of-sight and signal range.
	Remote receiver is faulty.	Inspect receiver circuit board; replace if faulty.
	Incorrectly wired motor connection.	Rewire or call certified service technician or electrician.
	On-board circuit breaker is tripped.	Allow motor to cool, improve ventilation, press reset button.
	Wiring is open/has high resistance.	Check for broken wires or poor connections, repair as necessary.
	Faulty power switch.	Replace switch.
Excessive vibration or noise during operation.	Motor is at fault.	Test/repair/replace.
	Loose component.	Inspect and tighten all bolts/nuts.
	Loose or broken motor mount.	Tighten or replace as needed.
	Motor fan hitting fan cover.	Check fan and cover; replace as needed.
	Bad motor bearings.	Rotate shaft manually, check for grinding or loose shaft, replace bearings if needed.

LAGUNA

<p>Loud, repetitive noise, or excessive vibration coming from cyclone</p>	<p>Machine is on uneven surface.</p> <p>Damaged/Unbalanced impeller.</p> <p>Loose connections.</p> <p>Impeller is loose.</p> <p>Motor fan hitting fan cover.</p>	<p>Stabilize on a flat surface.</p> <p>Inspect impeller for dents, bends, loose fins. Replace if needed.</p> <p>Check and re-tighten all fasteners.</p> <p>Replace the motor and impeller.</p> <p>Check fan and cover; replace as needed.</p>
<p>Dust cyclone does not adequately collect dust or chips; poor performance.</p>	<p>Canister end cap is full.</p> <p>Filter is dirty.</p> <p>Restricted duct line.</p> <p>Suction route is too long or has too many sharp bends.</p> <p>Wet lumber is clogging ducts.</p> <p>Leaks in the duct work or too many open ports.</p> <p>Inadequate velocity in the main suction line.</p> <p>Wrong size ducting/ports used.</p>	<p>Empty canister end cap.</p> <p>Clean filter.</p> <p>Clean inlet splitter.</p> <p>Move machine closer to the point of suction, and rerun ducts to eliminate sharp bends.</p> <p>Use lumber with less than 20% moisture content.</p> <p>Repair all duct leaks and close any ports not being used.</p> <p>Increase velocity by opening 1 or 2 more blast gates to different branch lines.</p> <p>Re-size and re-install ducts and fittings.</p>
<p>Sawdust being blown into the air from the dust cyclone</p>	<p>Band clamp or end cap is not secure.</p> <p>Loose or damaged seals.</p>	<p>Re-install ensuring a tight fit.</p> <p>Replace seals and gaskets.</p>

Parts Breakdown

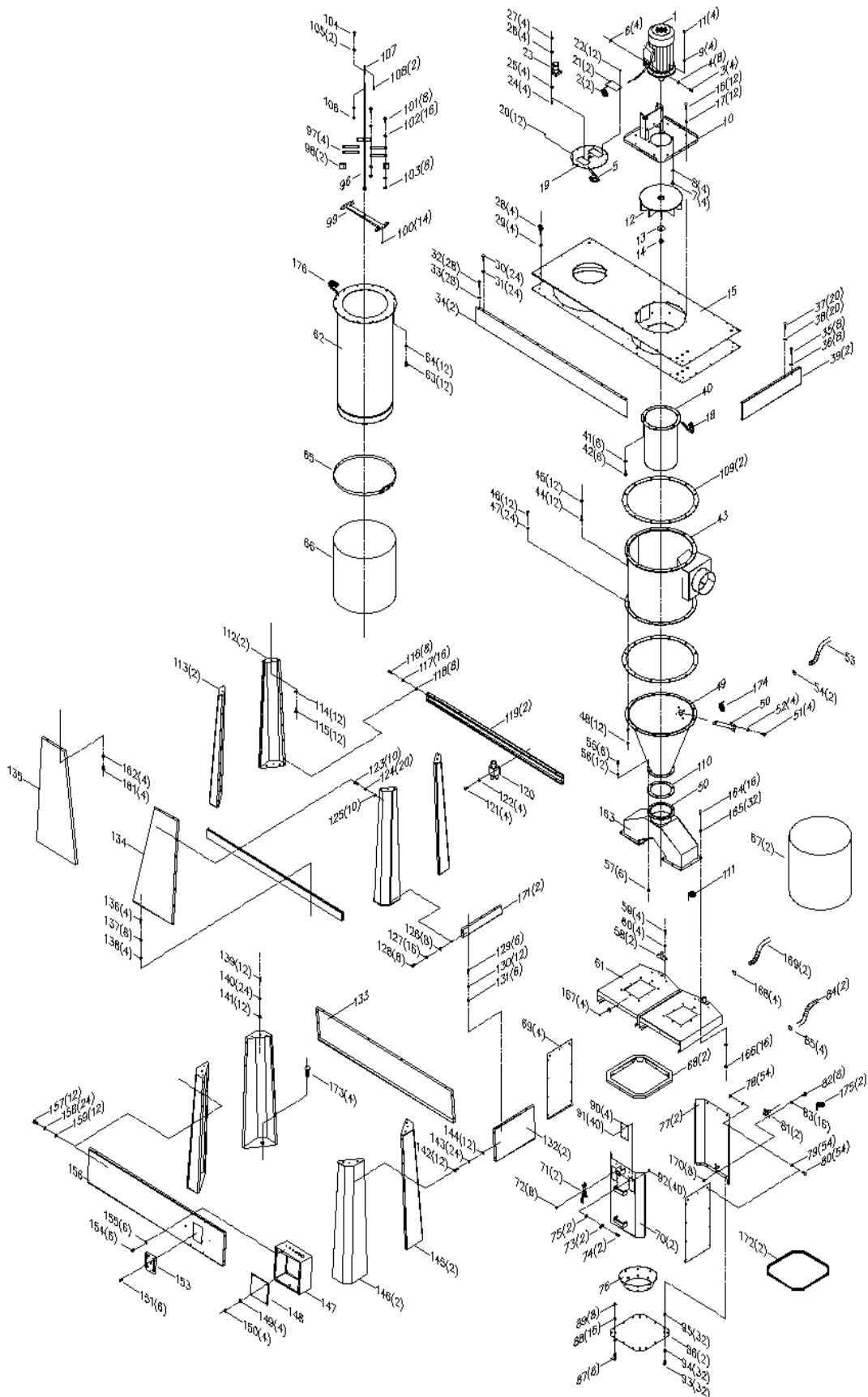

Part List

Ref No	Part Name	Description	Q'TY
1	MOTOR	10HP/220V/60Hz/3Phase	1
2	MOTOR GASKET		1
3	HEX BOLT	3/8"*1-1/2"	4
4	FLAT WASHER	3/8"*OD23*2t	8
5	FOAM TAPE	3*6mm	1
6	HEX NUT	3/8"	4
7	HEX BOLT	1/2"*1-1/2"	4
8	FLAT WASHER	1/2" *OD23*2t	4
9	FLAT WASHER	1/2"*OD23*2t	4
10	MOTOR SUPPORT BASE		1
11	HEX NUT	1/2"	4
12	IMPELLER	18-1/2"	1
13	MOTOR WASHER	3/4"*OD45*3t	1
14	MOTOR NUT	3/4"	1
15	DUST CHUTE		1
16	HEX BOLT	5/16"*3/4"	12
17	FLAT WASHER	5/16"*OD18*2t	12
18	FOAM TAPE	3*6mm	1
19	CANISTER COVER PLATE		1
20	SHEET METAL THREAD BOLT	3/16"*1/2"	12
21	COVER PLATE		2
22	SHEET METAL THREAD BOLT	3/16"*1/2"	12
23	GEAR MOTOR		1
24	LOCK NUT	M5	4

LAGUNA

Ref No	Part Name	Description	Q'TY
25	LOCK WASHER	3/16"	4
26	FLAT WASHER	3/16"*OD12*1t	4
27	HEX BOLT	M5*65L	4
28	EYE BOLT	M16*25mm	4
29	FLAT WASHER	5/8"*OD40*3t	4
30	HEX BOLT	3/8"*3/4"	24
31	FLAT WASHER	3/8"*OD23*2t	24
32	HEX BOLT	1/4"*3/4"	28
33	FLAT WASHER	1/4"*OD19*2t	28
34	DUST CHUTE SIDE PLATE	LONG	2
35	HEX BOLT	3/8"*3/4"	8
36	FLAT WASHER	3/8"*OD23*2t	8
37	HEX BOLT	1/4"*3/4"	20
38	FLAT WASHER	1/4"*OD19*2t	20
39	DUST CHUTE SIDE PLATE	SHORT	2
40	INTAKE CYLINDER		1
41	FLAT WASHER	5/16"OD18*2t	6
42	HEX NUT	5/16"*3/4"	6
43	CYCLONE BARREL		1
44	HEX BOLT	5/16"*3/4"	12
45	FLAT WASHER	5/16"OD18*2t	12
46	HEX BOLT	5/16"*1-1/4"	12
47	FLAT WASHER	5/16"*OD18*2t	24
48	LOCK NUT	5/16"	12
49	CYCLONE FUNNEL		1
50	CYCLONE FUNNEL VACUUM SUCTION TUBE		1

LAGUNA

Ref No	Part Name	Description	Q'TY
51	HEX BOLT	5/16"*3/4"	4
52	FLAT WASHER	5/16"*OD18*2t	4
53	FLEX HOSE	2"*560mm	1
54	HOSE CLAMP	2-1/4"	2
55	HEX BOLT	5/16"*1-1/4"	6
56	FLAT WASHER	5/16"*OD18*2t	12
57	HEX NUT	5/16"	6
58	DRUM VACUUM SUCTION TUBE		2
59	HEX BOLT	1/4"*3/4"	4
60	FLAT WASHER	1/4"*OD19*2t	4
61	DRUM LID		1
62	CANISTER FILTER	Ø750MM	1
63	HEX BOLT	5/16"*3/4"	12
64	FLAT WASHER	5/16"OD18*2t	12
65	SPRING BAG CLAMP	Ø750MM	1
66	CANISTER PLASTIC BAG		1
67	DRUM PLASTIC BAG		1
68	UPPER DRUM FRAME		1
69	SIDE DRUM PANELS		2
70	FRONT DRUM PANEL		1
71	QUICK RELEASE CLAMP		2
72	PHILIP HD BOLT	3/16"*3/8"	8
73	HANDLE LOCK NUT		2
74	HEX BOLT	1/4"*5/8"	2
75	HEX NUT	1/4"	2
76	VACUUM SUCTION RING		2

LAGUNA

Ref No	Part Name	Description	Q'TY
77	BACK DRUM PANEL		2
78	PHILIP HD BOLT	5/16"*5/8"	54
79	FLAT WASHER	5/16"*OD18*2t	54
80	HEX NUT	5/16"	54
81	DRUM VACUUM SUCTION TUBE		2
82	HEX BOLT	5/16"*3/4"	8
83	FLAT WASHER	5/16"*OD18*2t	16
84	FLEX HOSE	1-1/4"	2
85	HOSE CLAMP	1-1/4"	4
86	DRUM BASE PANEL		2
87	DRUM WHEEL	2"	8
88	FLAT WASHER	3/8"*OD23*2t	16
89	HEX NUT	3/8"	8
90	WINDOW		4
91	RIVET	3-2	40
92	FLAT WASHER	5/196"*OD18*2t	40
93	PHLIP HD BOLT	5/16"*5/8"	32
94	FLAT WASHER	5/16"*OD18*2t	32
95	NUT	5/16"	32
96	ROTATION SHAFT		1
97	PADDLE		4
98	CANVAS		2
99	ROTATION SHAFT SUPPORT BASE		1
100	SHEET METAL THREAD BOLT	3/16"*3/4"	14
101	HEX BOLT	1/4"*5/8"	8
102	FLAT WASHER	1/4"*OD013*1t	16

LAGUNA

Ref No	Part Name	Description	Q'TY
103	LOCK NUT	1/4"	8
104	HEX BOLT	5/16"*1-1/2"	1
105	FLAT WASHER	5/16"*OD18*2t	2
106	HEX LOCK NUT	5/16"	1
107	GEAR MOTOR SHAFT		1
108	HEX BOLT	M4*10mm	2
109	CYCLONE FUNNEL FLANGE		2
110	FUNNEL END FLANGE GASKET	9"*6holes	1
111	FOAM TAPE	3/6mm	1
112	TOP UPRIGHT SUPPORT	RIGHT	2
113	TOP UPRIGHT SUPPORT	LEFT	2
114	FLAT WASHER	3/8"*OD23*2t	12
115	HEX BOLT	3/8"*3/4"	12
116	HEX BOLT	3/8"*1"	8
117	FLAT WASHER	3/8"*OD23*2t	16
118	LOCK NUT	3/8"	8
119	TOP UPPER SUPPORT BRACE		2
120	VACUUM CONNECTOR		1
121	HEX BOLT	1/4"*3/4"	4
122	FLAT WASHER	1/4"*OD19*2t	4
123	HEX BOLT	3/8"*1"	10
124	FLAT WASHER	3/8"*OD23*2t	20
125	LOCK NUT	3/8"	10
126	LOCK NUT	3/8"	8
127	FLAT WASHER	3/8"*OD23*2t	16
128	HEX BOLT	3/8"*1"	8

LAGUNA

Ref No	Part Name	Description	Q'TY
129	HEX BOLT	3/8"*1"	6
130	FLAT WASHER	3/8"*OD23*2t	12
131	LOCK NUT	3/8"	6
132	HORIZONTAL SIDE PANEL	SHORT	2
133	HORIZONTAL BACK PANEL		1
134	TRIANGULAR COVER PANEL	RIGHT	1
135	TRIANGULAR COVER PANEL	LEFT	1
136	HEX BOLT	3/8"*1"	4
137	FLAT WASHER	3/8"*OD23*2t	8
138	LOCK NUT	3/8"	4
139	HEX BOLT	3/8"*1"	12
140	FLAT WASHER	3/8"*OD23*2t	24
141	NUT	3/8"	12
142	HEX BOLT	3/8"*1-1/2"	12
143	FLAT WASHER	3/8"*OD23*2t	24
144	LOCK NUT	3/8"	12
145	LOWER UPRIGHT SUPPORT	RIGHT	2
146	LOWER UPRIGHT SUPPORT	LEFT	2
147	CONTROL BOX		1
148	TERMINAL PANEL		1
149	FLAT WASHER	5/16"*OD18*2t	4
150	NUT	5/16"	4
151	PHLIP HD BOLT	3/16"*3/8"	6
153	CONTROL PANEL		1
154	HEX BOLT	1/4"*3/4"	6
155	FLAT WASHER	1/4"*OD19*2t	6

LAGUNA

Ref No	Part Name	Description	Q'TY
156	FRONT HORIZONTAL PANEL		1
157	HEX BOLT	3/8"*1"	12
158	FLAT WASHER	3/8"*OD23*2t	24
159	LOCK NUT	3/8"	12
161	HEX BOLT	3/8"*3/4"	4
162	FLAT WASHER	3/8"*OD23*2t	4
163	CONNECTOR		1
164	HEX BOLT	3/8"*1"	16
165	FLAT WASHER	3/8"*OD23*2t	32
166	LOCK NUT	3/8"	16
167	PHILIP HD BOLT	3/16"*3/8"	4
168	HOSE CLAMP	1-1/4"	4
169	FLEX HOSE	1-1/4"*730mm	2
170	NUT	5/16"	8
171	TOP HORIZONTAL SUPPORT BRACE		2
172	RUBBER SEAL	2.2M	2
173	HEX BOLT	M16*50mm	4
174	FOAM TAPE	3*6mm	1
175	FOAM TAPE	3*6mm	1
176	FOAM TAPE	3*6mm	1

LAGUNA

NOTES

LAGUNA

2072 Alton Parkway. Irvine, CA 92606
Ph: 800.234.1976 | www.lagunatools.com

Laguna Tools is not responsible for errors or omissions.
Specifications subject to change. Machines may be shown with optional accessories.

© 2018, Laguna Tools, Inc. LAGUNA® and the LAGUNA Logo® are the
registered trademarks of Laguna Tools, Inc. All rights reserved.